

15M300

SOUND REINFORCEMENT



This 15" high efficiency bass and mid transducer is designed for professional high performance sound reinforcement systems. It incorporates low mass edgewound aluminium voice coil (3" diameter) and a massive vented magnetic structure. This model covers the bass and mid frequency range with smooth response, low harmonic distortion and excellent power capacity ability. This loudspeaker is well suited for high efficiency sound application, in compact size bass-reflex cabinets designs.

Este modelo de 15" de alto rendimiento, para reproducción de baja y media frecuencia en sistemas profesionales incorpora un sistema móvil extremadamente ligero gracias a una bobina de 3" realizada con hilo plano de aluminio, y un circuito magnético de gran tamaño, con ventilación forzada para aumentar la disipación de calor. Este altavoz está especialmente recomendado en aquellas aplicaciones de tamaño compacto que precisen un rendimiento importante y una calidad acústica de alto nivel.

SPECIFICATIONS

Nominal diameter	380 mm. 15 in.
Rated impedance	8 ohms.
Power capacity*	300 w RMS
Program Power	600 Watts.
Sensitivity	100 dB, 2.83v @ 1m @ 2π
Frequency range	30-3500 Hz
Recom. enclosure vol.	40/100 l 1.754/3.5 ft. ³
Voice coil diameter	77 mm. 3 in.
Magnetic assembly weight	8 kg. 21.12 lb.
BL factor	20.1 N/A
Moving mass	0.078 kg.
Voice coil length	16 mm.
Air gap height	9 mm.
X damage (peak to peak)	35 mm.

PREDICTED LOW FREQUENCY RESPONSE • Bass-reflex cabinet, Vb=70.00 l, fb=60.0 Hz

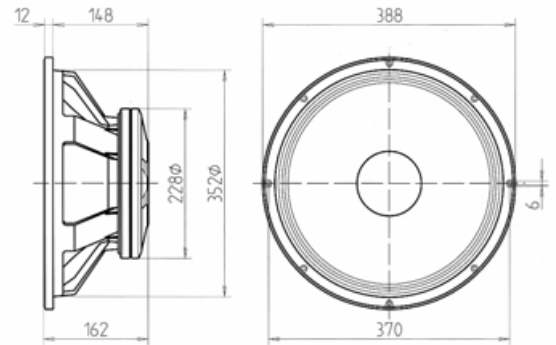
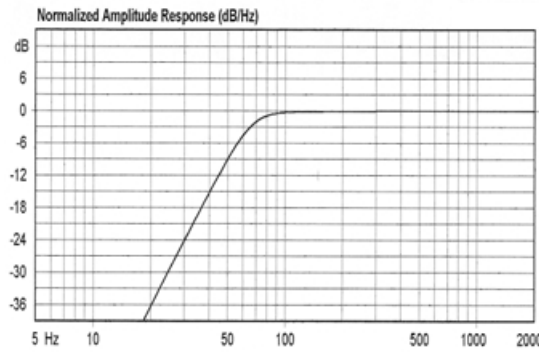

MOUNTING INFORMATION

Overall diameter	388 mm. 15.28 in.
Bolt circle diameter	370 mm. 14.56 in.
Baffle cutout diameter:	
-Front mount	352 mm. 13.85 in.
-Rear mount	355 mm. 13.97 in.
Depth	162 mm. 6.38 in.
Volume displaced by driver	7 l 0.25 ft. ³
Net weight	9.2 kg. 20.24 lb.
Shipping weight	10 kg. 22 lb.

FREQUENCY RESPONSE & DISTORTION CURVES, MAGN. On axis, 1w @ 1m.

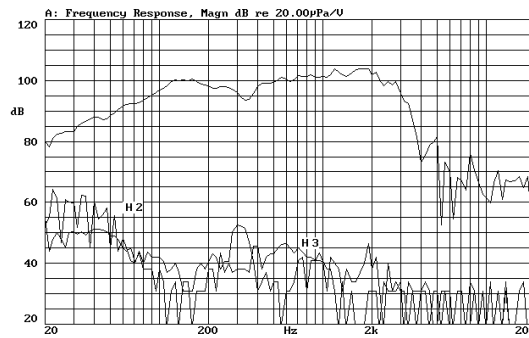

TIME RESPONSE, MAGN.

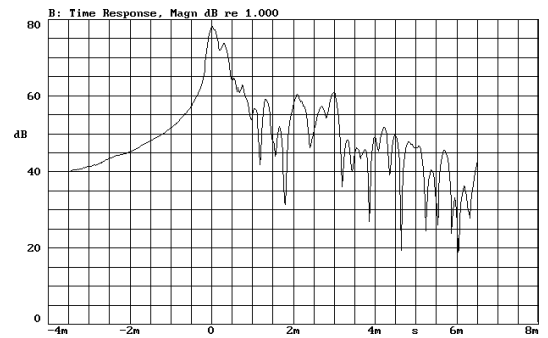

MATERIALS

Basket	Die Cast aluminium
Cone	Paper
Surround	Plasticised cloth
Voice coil	Edgewound alum. ribbon
Magnet	Ferrite

THIELE-SMALL PARAMETERS**

Resonant Frequency, fs	40 Hz
D.C. Voice Coil Resistance, Re	5.8 ohms.
Mechanical Quality Factor, Qms	8.1
Electrical Quality Factor, Qes	0.28
Total Quality Factor, Qts	0.27
Equivalent Air Volume to Cms, Vas	220 l
Mechanical Compliance, Cms	248 μm/N
Mechanical Resistance, Rms	2.42 kg/s
Efficiency, ηo (%)	4.8
Effective Surface Area, Sd(m ²)	0.088 m ²
Maximum Displacement, Xmax	3.5 mm.
Displacement Volume, Vd	310 cm. ³
Voice Coil Inductance, Le @ 1kHz	1.3 mH

FREQUENCY RESPONSE, PHASE. On axis, 1w @ 1m.

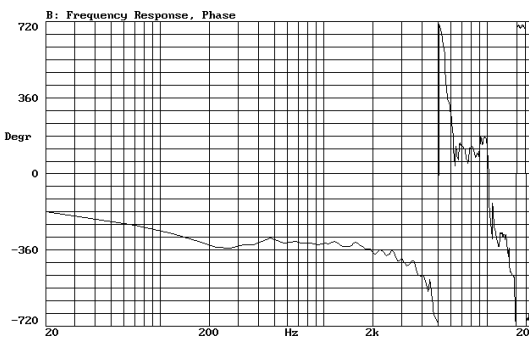

FREE AIR IMPEDANCE CURVE

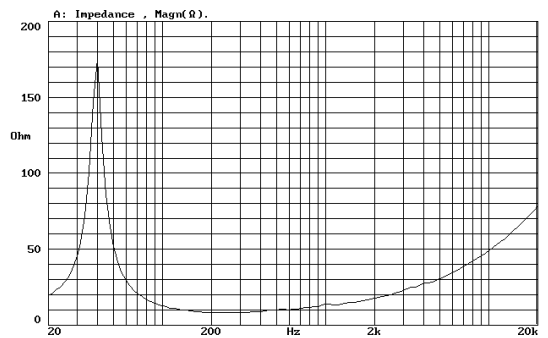

VOICE COIL INDUCTANCE CURVE

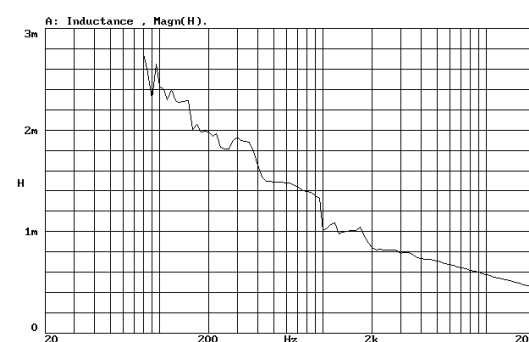

Re + Red(w) CURVE

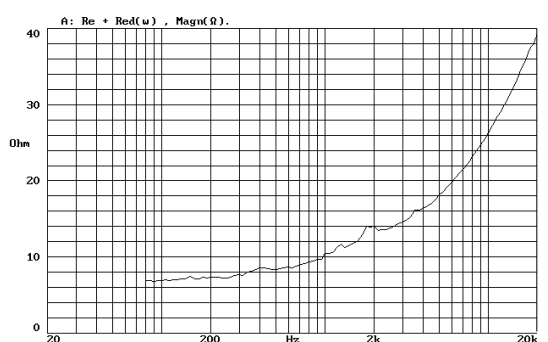

NOTES
*The power capacity corresponds to the RMS maximum value that can dissipate the loudspeaker when a sinus signal is applied for a period of at least two hours.
Program power is defined as the transducer's ability to handle normal music program material.

** T-S parameters are measured after an exercise period using a preconditioning power test, using a velocity-current laser transducer, and will reflect the long term parameters, once the loudspeaker has been working for a short period of time.

NOTAS
*La potencia admisible corresponde a la máxima potencia RMS que puede disipar el altavoz durante al menos dos horas, cuando se le aplica una señal senoidal determinada.
Por potencia programa se entiende la capacidad del altavoz en el manejo de señales transitorias, como sería el proporcionado por el contenido de un pasaje musical normal.

* Los parámetros T-S han sido medidos después de un periodo de fatiga y estabilización de las suspensiones, mediante transductor laser de velocidad-corriente, y son el reflejo de los parámetros a largo plazo del altavoz, una vez éste haya sido instalado y haya trabajado en un corto espacio de tiempo.